

BOLTSCREEN

Assembly Instruction Manual

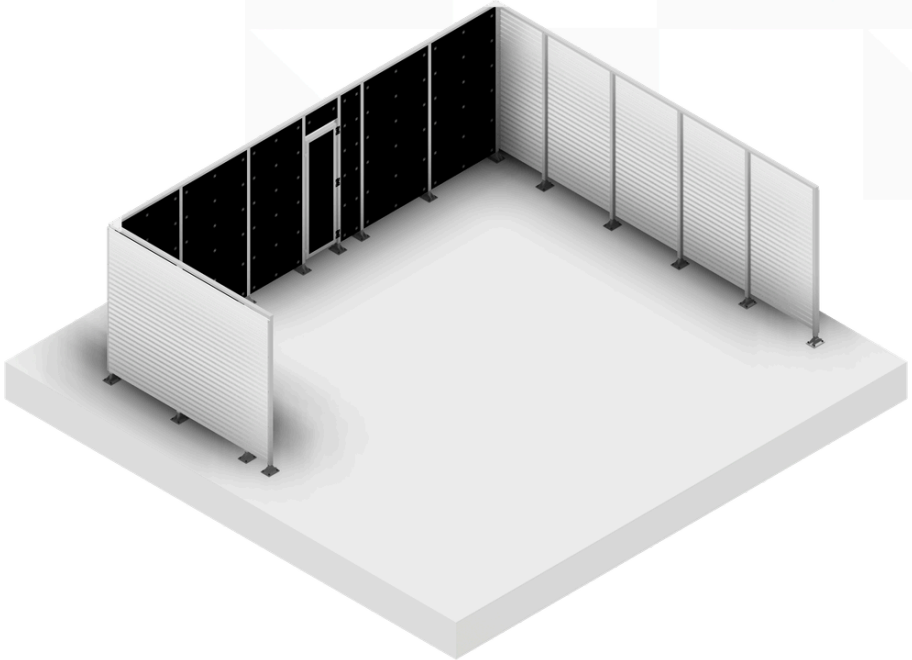

Configured**Platforms**[®]



Prefabricated plant enclosures & platform systems

 **value**engineering[®]

+44 (0)113 276 0450

TechnicalSupport@configuredplatforms.co.uk

www.configuredplatforms.com

Configured **Platforms**[®]

 **value** engineering[®]

BOLTSCREEN

Screen System Fixed



M12 **Bolt Sets**

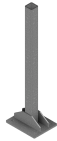

Boltscreen **Post Feet**



Resin



Heavy Gauge
Tek Screw



Zinc **Spray**



Shims



Boltscreen
Jig



Post **Jig**

Configured **Platforms**[®]

 **value** engineering[®]

SCREENS

Surround systems



Post



20mm **Tek Screws**



Corner Red **Bracket**



U-Channel



U-Channel **Splice**



Peacemaker



Door



Soundshield



65mm **Tek Screw +**
Hold Down **Disc**



16mm **Tek Screws**

Configured **Platforms**[®]

 **value** engineering[®]

Standard Screen

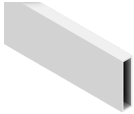

Slat



Slat Splice

Louvre Screen



Louvre

Flatscreen



Peaceflow

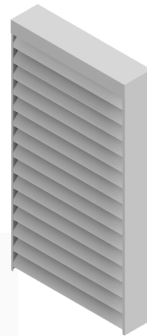

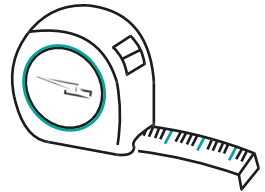
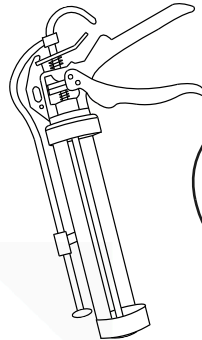
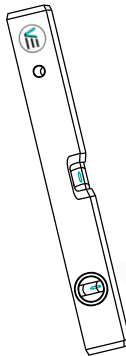
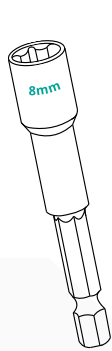
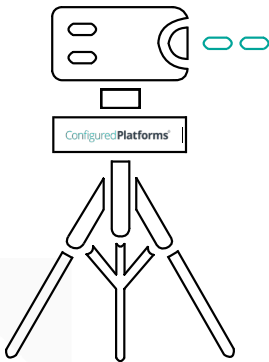
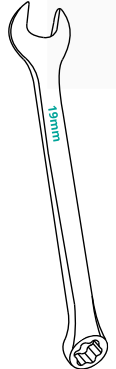
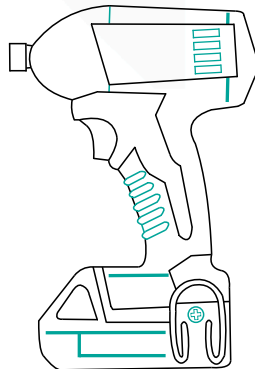
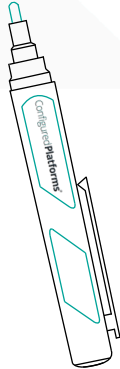
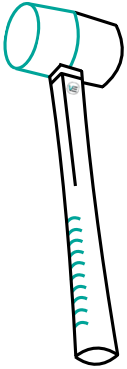

1

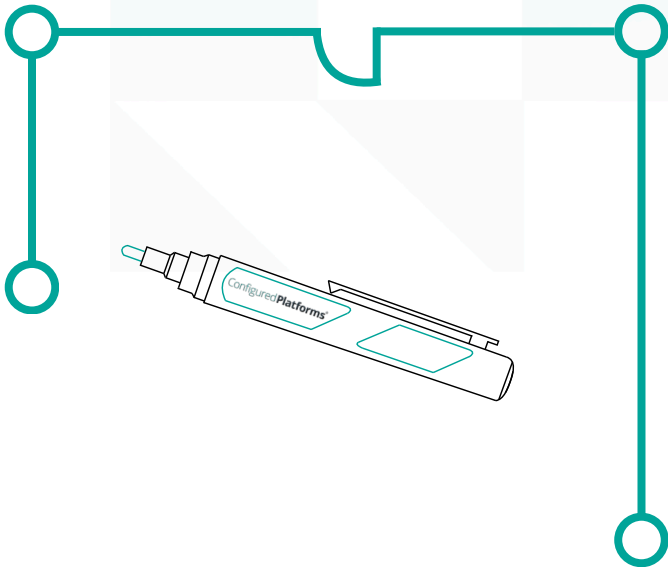

1. Mark the location of end, corner and any door or openings as per **Plan Drawing**.

2

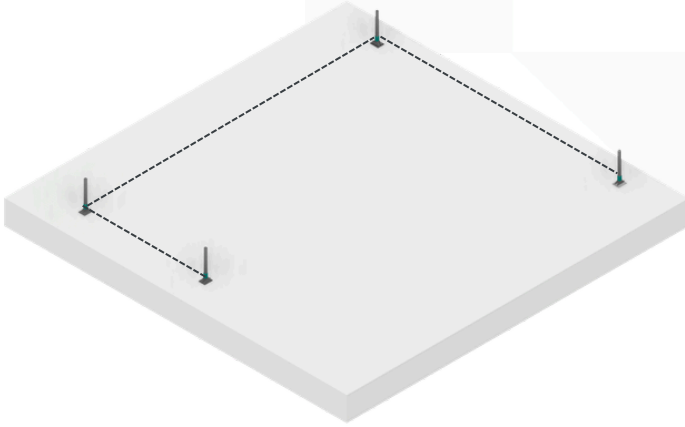

Boltscreen **Post Feet**



Post **Jig**

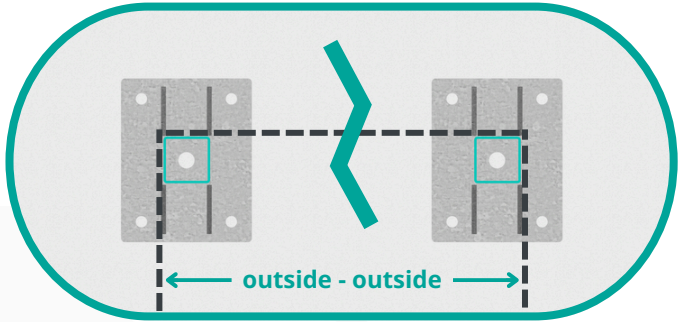
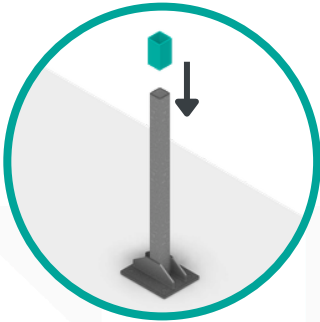

2. Position corner or end **Boltscreen Post Feet**. See **Plan Drawing** for layout. Overall measurements are **outside to outside** of **Post Jig**. See **Step 4** for fixing.

3

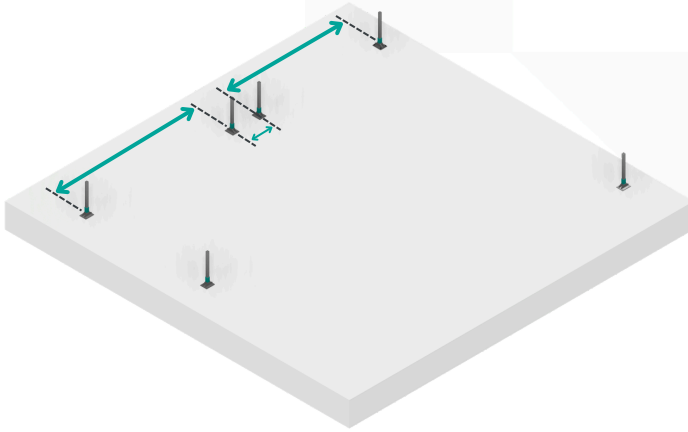

Boltscreen **Post Feet**



Post **Jig**

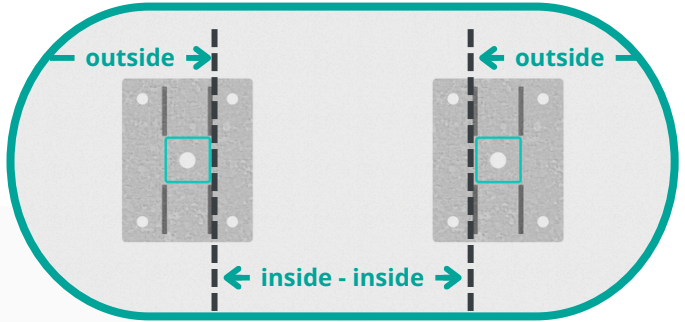
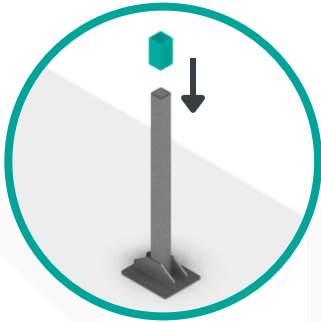

3. Mark out locations of the door or openings. See **Plan Drawing** for layout, measurements are **inside to inside** of **Post Jigs** for the opening. See **Step 4** for fixing.

4



Shims



Zinc Spray



Resin



M12 Bolt Sets

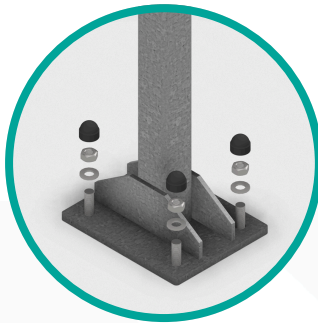
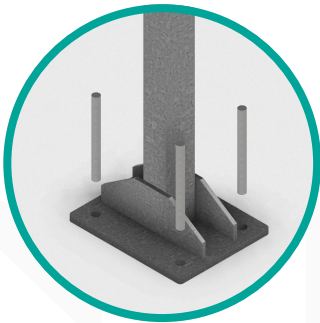

4. Fix all **Boltscreen Post Feet** that have been located to corners, ends and door or openings. See **Plan Drawing** for any fixing specifications. Use **Shims** as required to plumb the **Boltscreen Post Feet**. Studs are not to protude above nut/cap, cut off and treat with **Zinc Spray**.

5

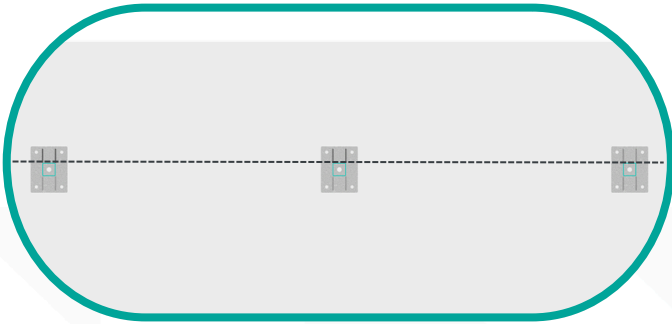
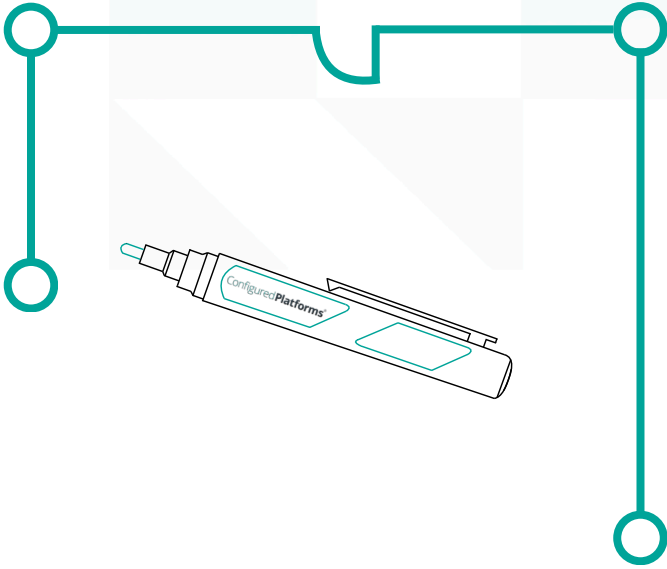

5. String line or laser front of posts from extents to set position of intermediate **Boltscreen Post Feet** line.

6

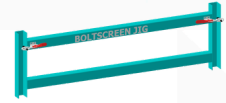
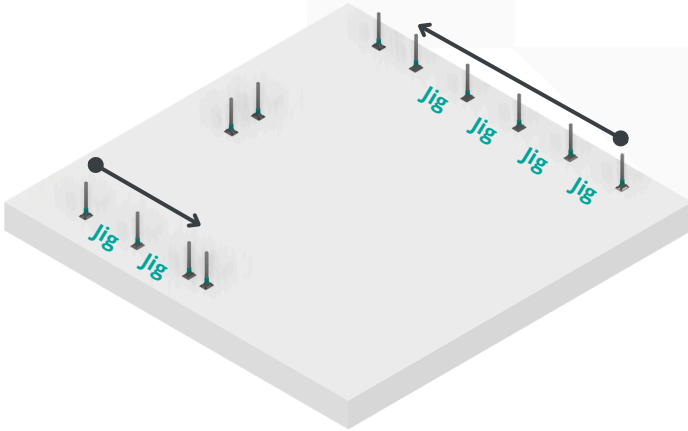

Boltscreen **Post Jig**



Boltscreen **Post Foot**

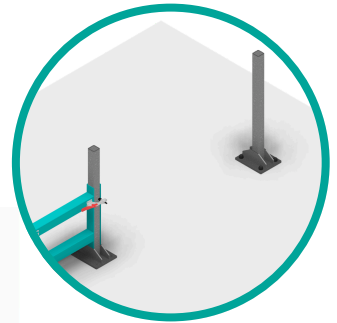
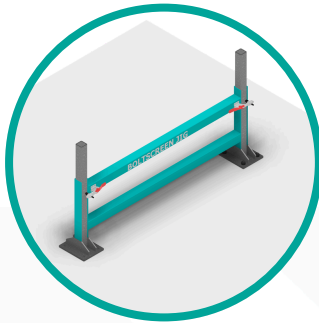
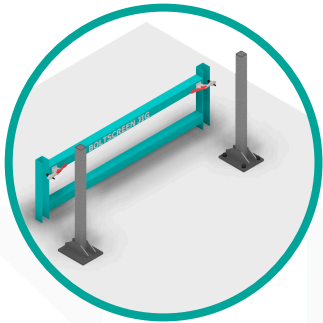

6. For sides that have no openings and no specific **Post** positions are shown on the **Plan Drawing**. Use the **Boltscreen Jig** and start from the inside right to space and fix the **Boltscreen Post Feet**. See **Step 8** for fixing.

7

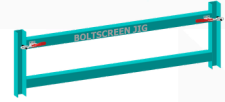
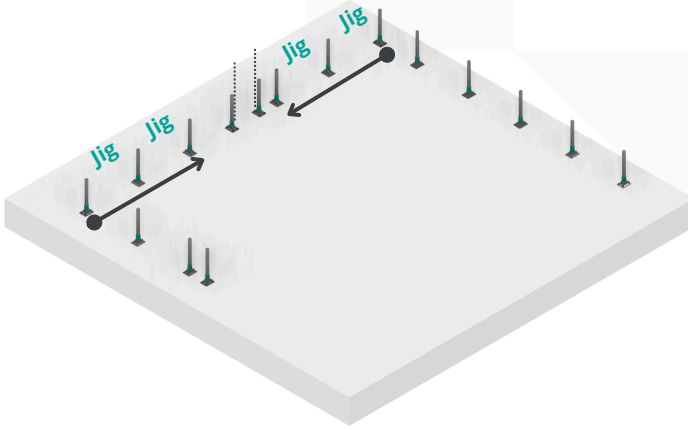

Boltscreen **Post Jig**



Boltscreen **Post Foot**

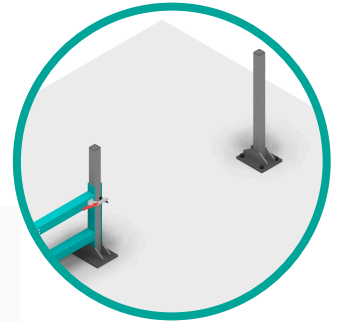
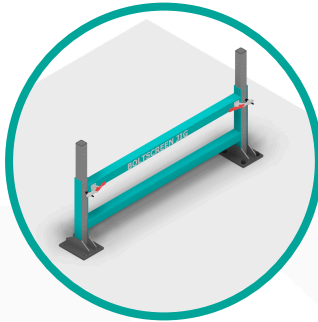
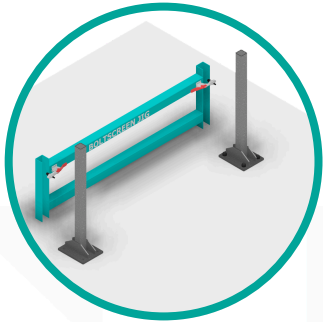

7. For sides with openings or doors and no specific positions are shown on the **Plan Drawing**. Use the **Boltscreen Jig** working towards the door or opening from either end to space and fix the **Boltscreen Post Feet**. See **Step 8** for fixing. The remaining distance will be to the left and right side of the door or opening.

8



Shims



Zinc Spray



Resin



M12 Bolt Sets

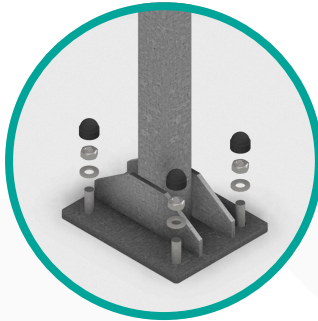
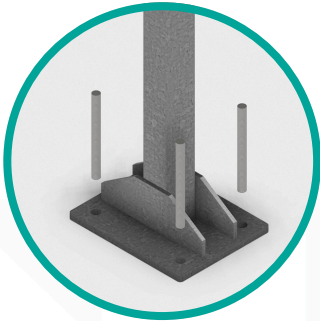

8. Fix all **Boltscreen Post Feet** that have been located. See **Plan Drawing** for any fixing specifications. Use **Shims** as required to plumb the **Boltscreen Feet**. Studs are not to protrude above nut/cap, cut off and treat with **Zinc Spray**. Waterproofing can be carried out at this stage.

9

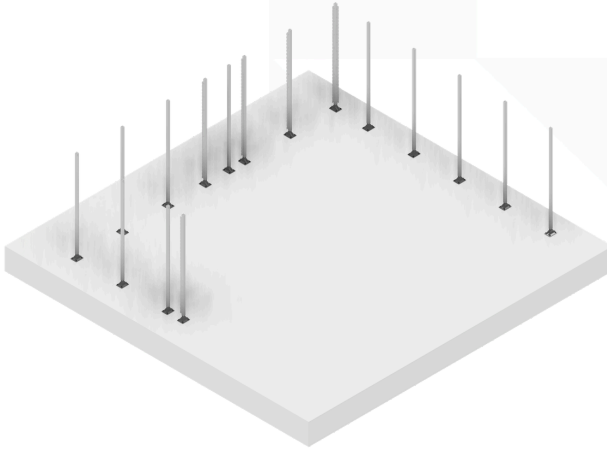

Posts

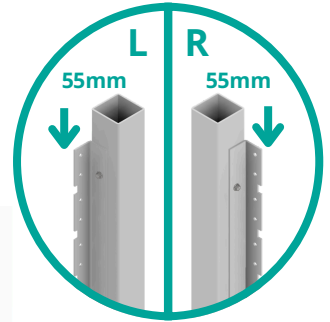
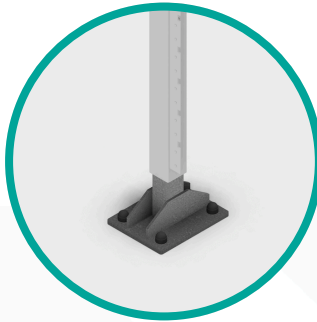
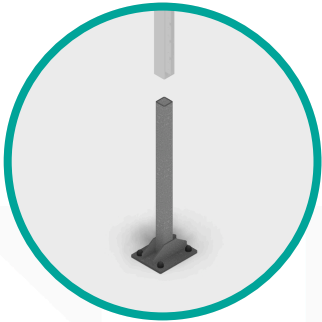

9. Offer the posts onto the **Boltscreen Post Feet** as **Plan Drawing**. See **Plan Drawing** to correctly position any **Left/Right** and **Corner posts**. Screws holding **Spacer Angle** or **Louvre Clips** that interfere with the **Boltscreen Post Foot** require removing.

10

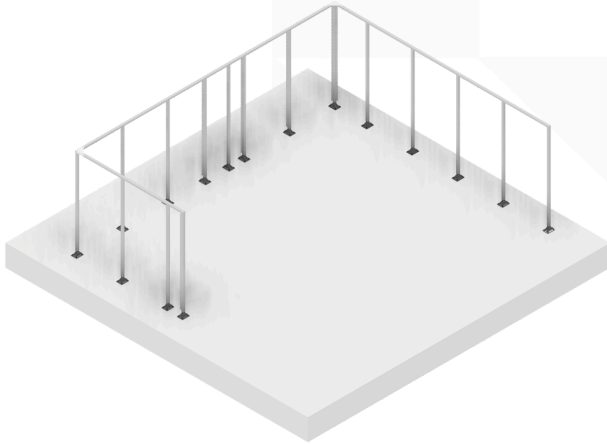

U-Channel



U-Channel Splice



Corner Red Bracket



20mm Tek Screws



10. Use the **Plan Drawing** for the location of the **U-Channel**. Place each **U-Channel** over the top of the **Posts** and fix them on the corners using the **Corner Red Brackets**. If a run has multiple **U-Channel Lengths**, connect using **U-Channel Splices** and **20mm Tek Screws**.

11

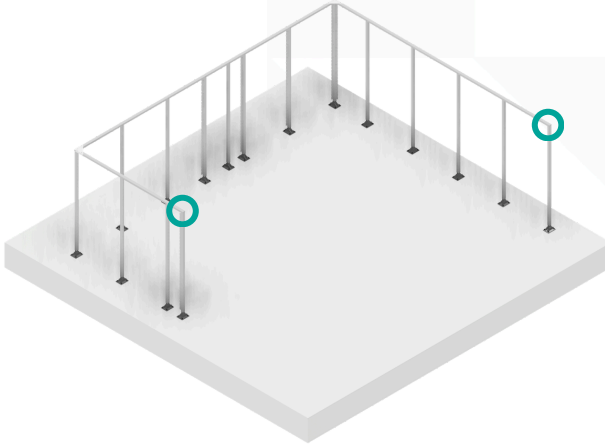

20mm Tek Screws

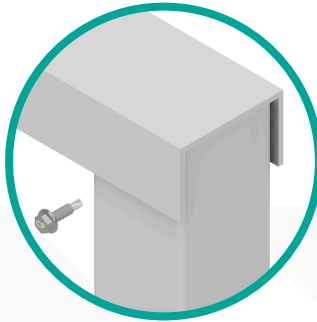

11. Fix the **U-Channel** to the post centrally on the inside face with **20mm Tek Screws**.

12

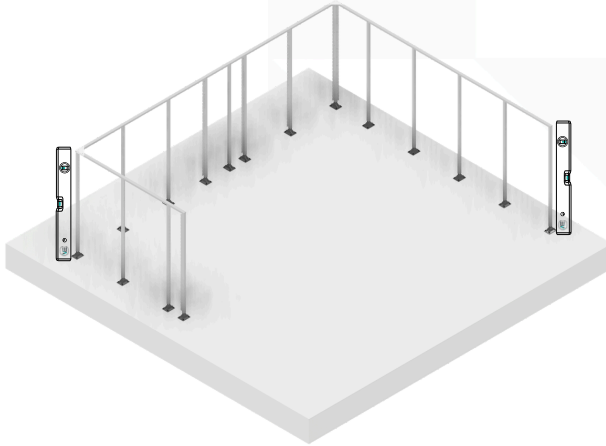

20mm **Tek Screw**



Spacing **Jig**



12. Vertically plumb all **Corner** and **End Posts** in both directions, then plumb each of the remaining posts using the **Spacing Jig** between the top of the posts. Fix each **Post** to the **U-Channel** on the inside face. Use **20mm Tek Screws**. Fix any screws that were removed to place the **Posts** on the **Post Feet**.

13

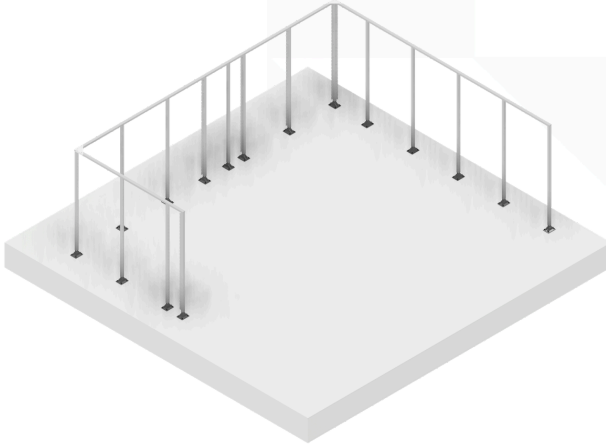

20mm **Tek Screws**

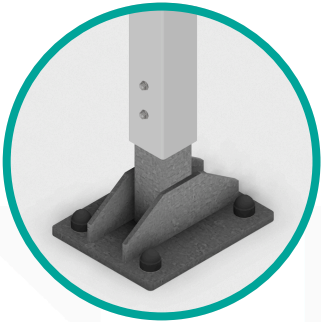

13. Check the highest point and fix **Post** with min. 2x **20mm Tek Screws**. Level all other **Posts** and fix with min. 2x **20mm Tek Screws** once the top of the screen is level.

14

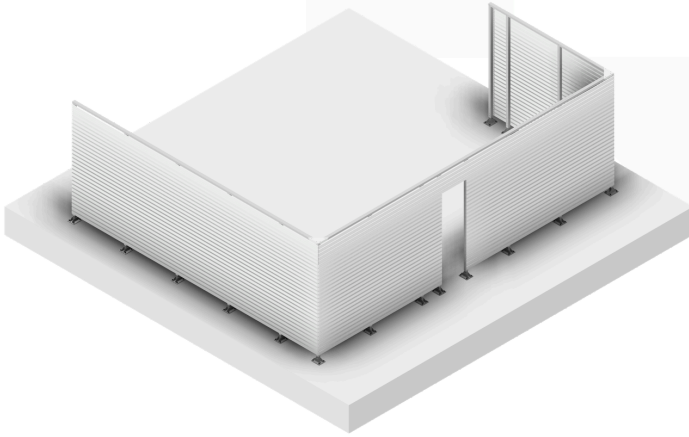

Screen **Slat**



16mm **Tek Screws**

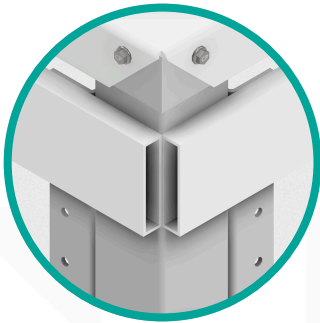

14. Establish from the **Plan Drawing** where each length of **Slat** goes. Begin at a corner and fix the **Slats** to the **Spacer Angle** using **16mm Tek Screws**. Working from the top slat down, keep each slat flush with the outside of the **Corner Post**. If no gap **Slat**, the **Slat** will be fitted without gap. Go to **Step 17**.

15

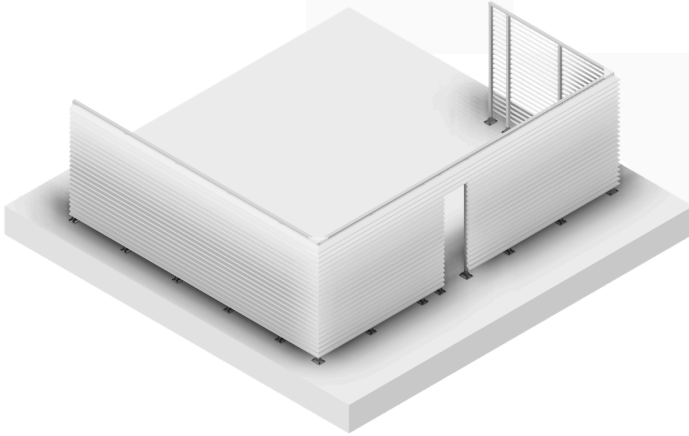

Louver



20mm Tek Screws

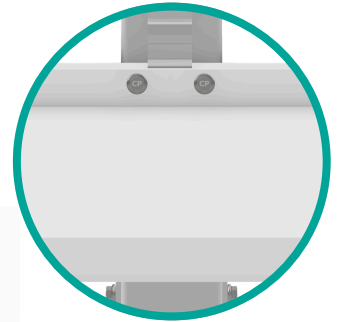
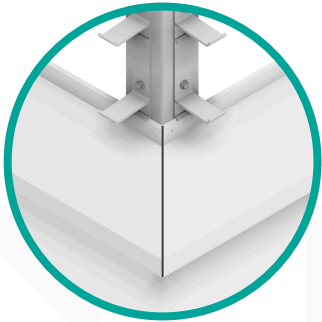

15. Establish from the **Plan Drawing** where each length of **Louvre** goes. Begin at a corner and place a **Louvre** into the bottom louver clip, fix the **Louvers** to the **Post** with 2x **20mm Tek Screws**. Work from the bottom louver upwards, or the top downward if inverted **Louvre** is specified. Ensure corner mitres meet level. Go to **Step 18**.

16

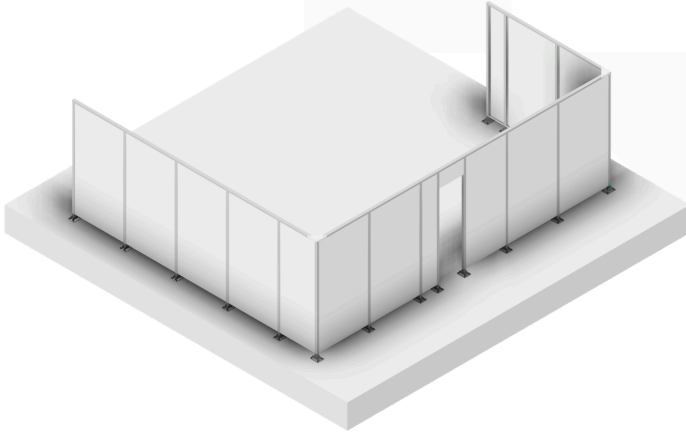

Flatscreen Panel



20mm Tek Screws

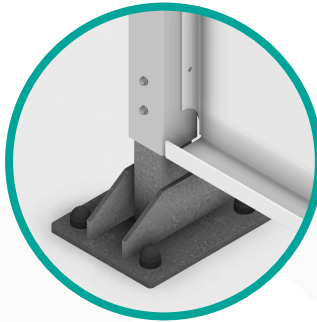

16. Establish from the **Plan Drawing** where each **Flatscreen Panel** goes. Fit the **Flatscreen Panel** with single flange to the inside of the **U-Channel**. Flush the front face of the **Flatscreen Panel** with the front of the **Posts**. Fix in all holes provided with **20mm Tek Screws**. Go to **Step 20**.

17

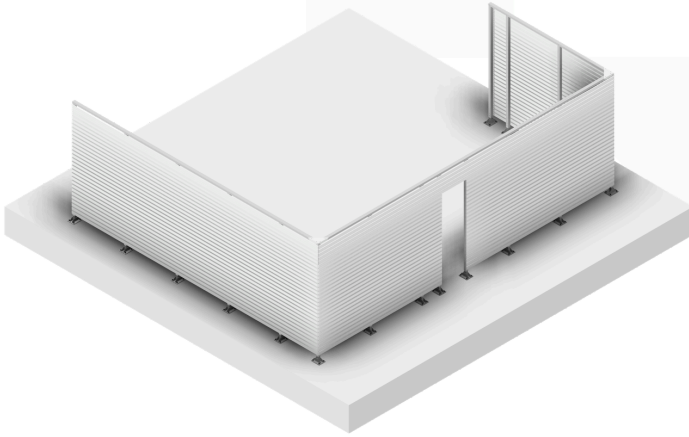

Screen **Slat**



Slat **Splice**



16mm **Tek Screws**

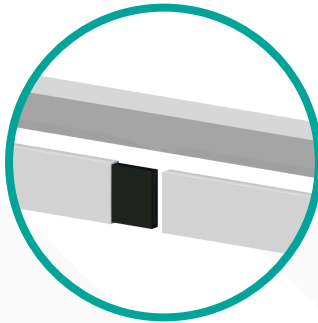
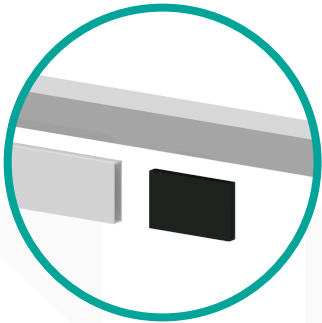

17. If there are multiple lengths of slat on one run, fix the first lengths as **Step 15** then tap in the **Slat Splices** into the ends. Then tap the **Slat** over the **Slat Splice**, continue to fix as **Step 15**. Go to **Step 19**.

18

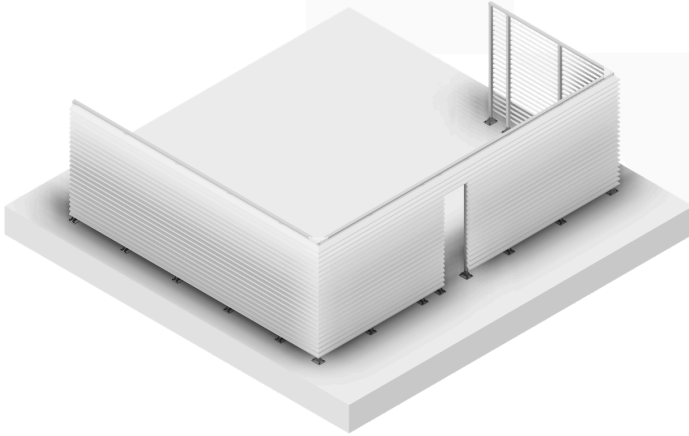

Louver



20mm Tek Screws

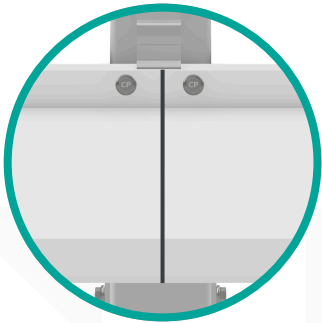

18. If there are multiple lengths of **Louvre** on one run, fix the first lengths as **Step 15**. The **Louvre** joint is centred on the post. Fix with 1x **20mm Tek Screw** at the end of each **Louvre**. Go to **Step 20**.

19

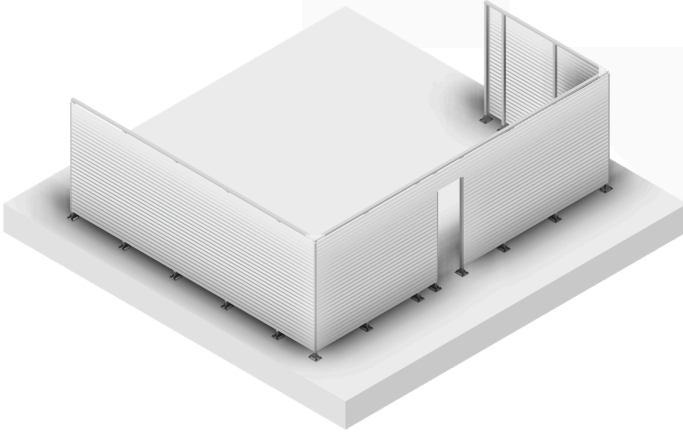

Trim Angles



16mm Tek Screws

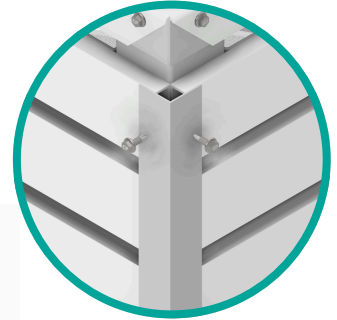
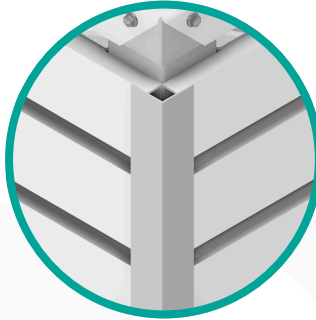
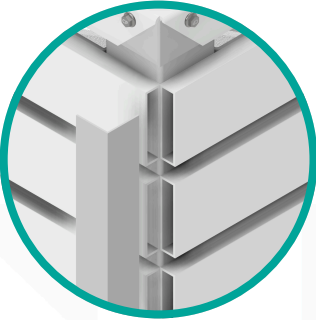

19. Once all the **Slats** are in place, fix the **Trim Angles** to each external corner and to any the open **Slat** ends using **16mm Tek Screws**. Fix at min. centres vertically 560mm, if a door is present, copy factory fitted fixing positions.

20

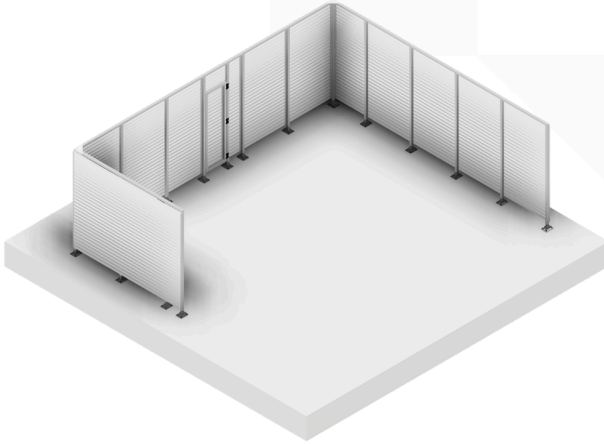

Door



Door Hinge



20mm Tek Screws

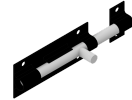

Pad Bolt

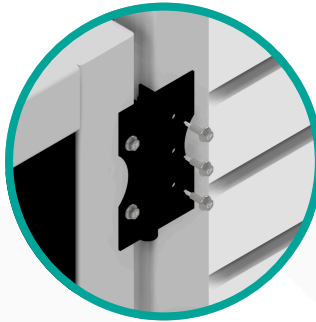

20. Fix the door in place using all holes in **Hinges** using **20mm Tek Screws** ensuring that the **Door** opens as **Plan Drawing**. The **Slats** on the door should line through with the **Slat** on the **Screen**. Fix the **Pad Bolts** as site requirements using **20mm Tek Screws**.

21

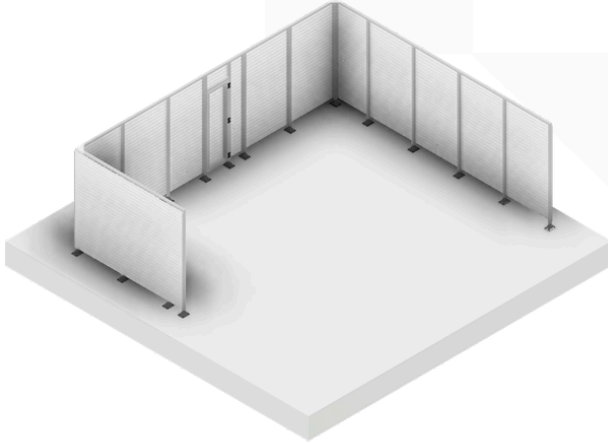

Overdoor Rail



20mm Tek Screws

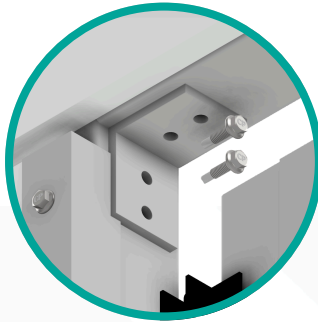
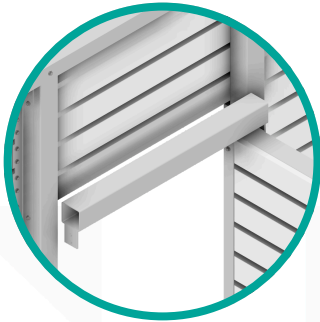

21. Fix the **Overdoor Rail** using **20mm Tek Screws** as **Plan Drawing**. Go to **Step 22** if **Standard Screen** or **Louvre**, **Step 24** if **Flatscreen/Peaceflow**.

22

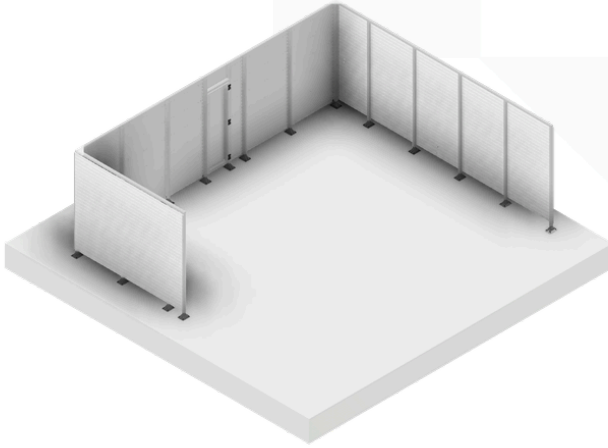

Soundshield



16mm Tek Screws

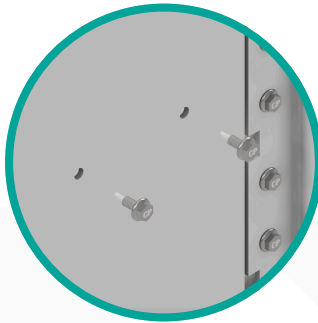

22. If **Soundshield**, establish from the **Plan Drawing** the location of each **Soundshield Panel**. Tuck the top (marked with a V) of the panels into the **U-Channel**. The **Soundshield** should not overlap **Spacer Angle**. When into **Slat** fix with **16mm Tek Screws**, do not use **20mm Tek Screws** as they will penetrate the front. If **Standard Screen** go to **Step 23**, **Step 24** if **Louvre**.

23

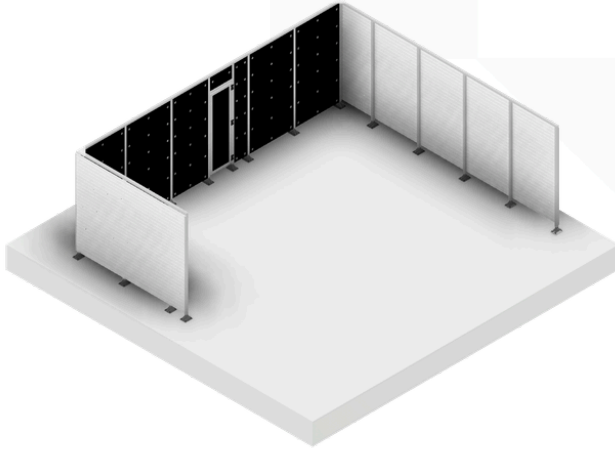

Peacemaker



65mm Tek Screw
with Disc

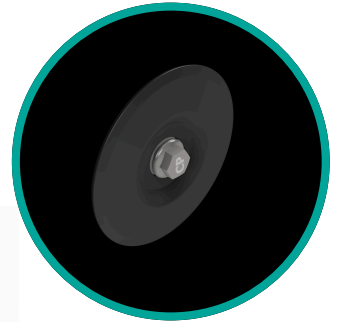
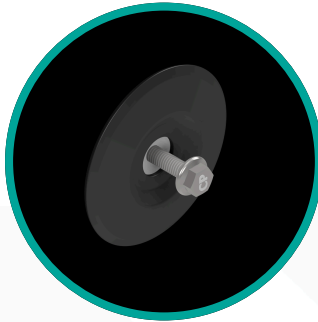

23. To install **Peacemaker**, tuck each **Peacemaker Panel** into the **U-Channel**. Fix through the **Peacemaker** into the slat using the **65mm Tek Screw + Disc**. Only turn the screw two threads into the back of the **Slats** or they will penetrate the front of the **Slat**. **Acoustic+** is a combination of **Soundshield/Peacemaker**, follow the steps in order.

24

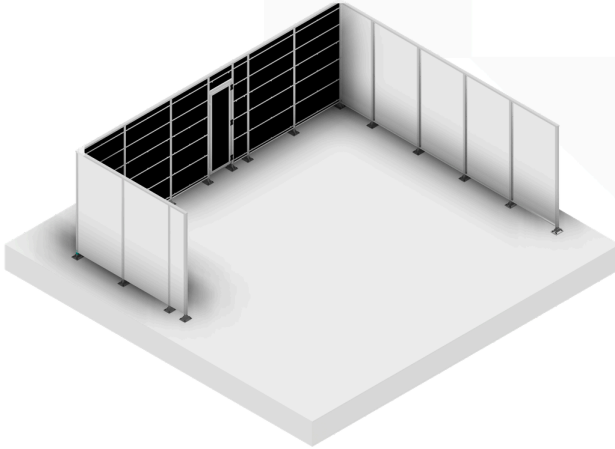

Peacemaker



Fixing Strap



20mm Tek Screws



24. To install **Peacemaker**, tuck the top of each **Peacemaker Panel** into the **U-Channel**. See **Plan Drawing** for location of **Fixing Straps**, they should run through over the white marks on the **Peacemaker**. Fix to posts with **20mm Tek Screws** through all holes provided. **Acoustic+** is a combination of **Soundshield/Peacemaker**, follow the steps in order.